

# 5MP HD Fixed IR Turret Analog Camera

UAC-T115-F28(40)



## Introduction

UAC-T115-F28/F40 is a 5MP HD Fixed IR Turret Analog Camera with a high-performance 1/2.7-inch CMOS sensor. It supports TVI/AHD/CVI/CVBS, which effectively enhances product adaptability and diversity of networking solutions. With SYV-75-3 or other coaxial cable types the camera can achieve low-cost, long-distance, anti-interference, and low delay mega-pixel HD video transmission. The camera supports IR cut filter and provides color images at daytime and black/white images at night.

## Features

- 5MP high quality image
- TVI/AHD/CVI/CVBS
- IR-cut filter with auto switch (ICR)
- Supports 180° horizontal flip, 180° vertical flip
- OSD configuration menu, easy to operate
- IP67 waterproof and dustproof design, high reliability
- OSD configuration menu in 11 languages
- 3-Axis

## Specifications

Model	UAC-T115-F28	UAC-T115-F40
<b>Sensor</b>		
Pixel	5MP	
Size	1/2.7"	
Minimum illumination	0.02lux(F2.0, AGC ON) 0 lux (IR on)	
<b>Lens</b>		
Lens	2.8mm	4.0mm
Lens mount	M12	
Angle of view	H: 102.2° V: 53.9° D: 124.8°	H: 82.9° V: 46.1° D: 100.0°
<b>Illuminator</b>		
Illuminator	One IR illuminator	
Illumination distance	20m	
Lifetime	≥60,000 hours	
<b>Video</b>		
Resolution	5MP@25fps: 2880(H)×1620(V); 5MP@20fps: 2592(H)×1944(V); 5MP@12.5fps: 2592(H)×1944(V) 4MP: 2560(H)×1440(V) 2MP: 1920(H)×1080(V)	
Frame rate	TVI: 5MP@20fps, 5MP@12.5fps, 4MP@30fps, 4MP@25fps, 1080P@30fps, 1080P@25fps AHD: 5MP@20fps, 4MP@30fps, 4MP@25fps, 1080P@30fps, 1080P@25fps CVI: 5MP@25fps, 4MP@30fps, 4MP@25fps, 1080P@30fps, 1080P@25fps CVBS: PAL, NTSC	
Shutter time	PAL: 1/25s-1/50000s NTSC: 1/30s-1/50000s	
<b>Image</b>		
Exposure mode	4 modes: Global (default), BLC, HLC, DWDR	
Day/Night	3 modes: Auto (default), Day, Night	
Digital noise reduction	2D	
White balance	Two modes: Auto (default), Manual	
WDR	DWDR	
Smart IR	Support	
Flip	Supports 180° horizontal flip, 180° vertical flip.	
<b>Interface</b>		
Power	5.5mm power interface	
Video output	BNC, supports TVI/AHD/CVI/CVBS	
<b>Operating environment</b>		
Temperature	-30°C to 60°C (-22°F to 140°F)	
Humidity	≤95% (RH, non-condensing)	
Surge protection	4KV	
Ingress protection	IP67	
<b>General</b>		
Power	DC 12V(±25%), with reverse polarity protection and surge protection, Max 3.6W	
Mount	Ceiling mount (default), optional backbox, wall mount bracket	

Dimensions	Φ118mm*96mm (diameter*height)
Material	Plastic
Weight	182g(0.401lb)
Certification	CB, CE, FCC

## Dimensions

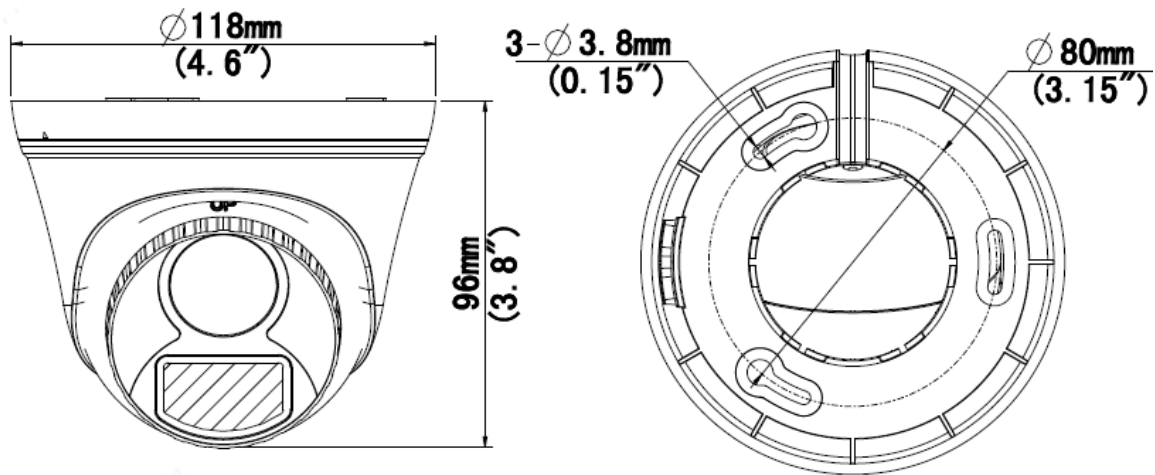

UAC-T115-F28(40)

## Accessories

TR-JB03-I-IN

Junction Box



TR-UP06-IN

Pole Mount



TR-JB07/WM03-G-IN

Wall Mount

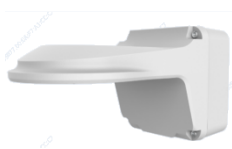

TR-UC08-C

Corner mount

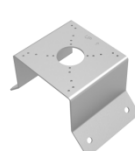

TR-WM03-D-IN

Wall Mount

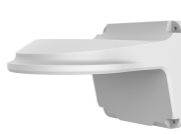

TR-SE24-A-IN

Pendant Mount



TR-WM07P-B

Wall mount



TR-CM24-IN

Pendant Mount



TR-A01-IN

Waterproof Joint



TR-SE24-IN

Pendant Mount



PWR-DC1201A-UK

PWR-DC1201A-US

PWR-DC1201A-EU

Wall Plug-in UK  
Power Adapter

Wall Plug-in US Power  
Adapter

Wall Plug-in EU  
Power Adapter



Mount

TR-JB07/WM03-G-IN(TR-WM03-D-IN)+TR-UP06-IN

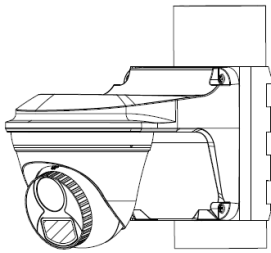

TR-JB03-I-IN

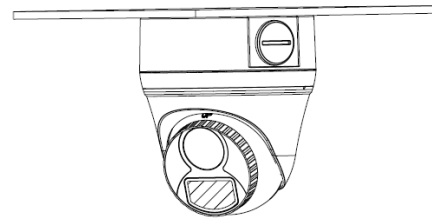

TR-JB07/WM03-G-IN(TR-WM03-D-IN)+TR-UC08-C

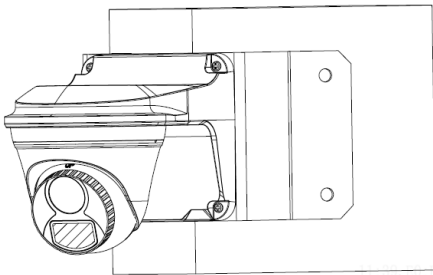

TR-CM24-IN+TR-JB03-I-IN

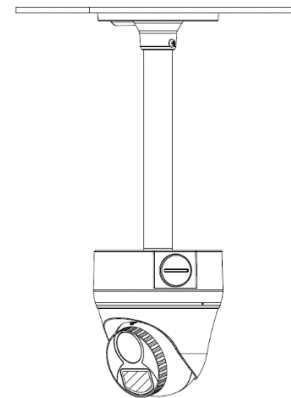

TR-WM07P-B

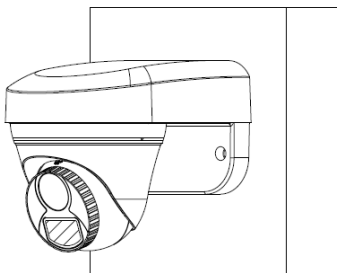

TR-JB07/WM03-G-IN(TR-WM03-D-IN)

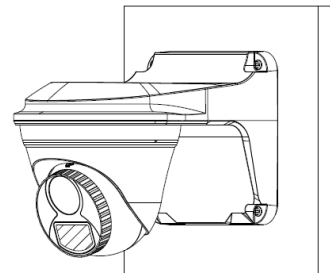

**Zhejiang Uniview Technologies Co., Ltd.**

Building No.10, Wanlun Science Park, Jiangling Road 88, Binjiang District, Hangzhou, Zhejiang, China (310051)

Email: [overseasbusiness@uniview.com](mailto:overseasbusiness@uniview.com); [globalsupport@uniview.com](mailto:globalsupport@uniview.com)

<https://www.uniview.com>

©2022 Zhejiang Uniview Technologies Co., Ltd. All rights reserved.

\*Product specifications and availability are subject to change without notice.